

L-WGSNP - Nylon standoff snap into rectangular hole

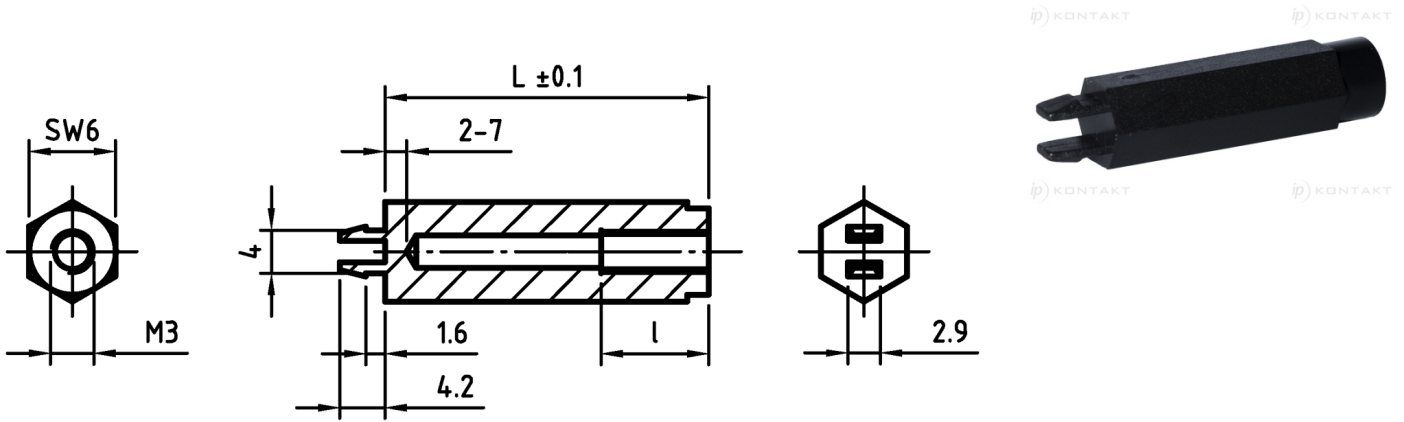

Details:

- **Material:** Polyamide
- **Colour:** black
- Thread: M3
- Panel thickness: 1.5 mm
- Rectangular mounting hole: 4 × 3 mm

Symbol	Height L	Int. thread	Int. thread length l	Wrench size SW	Color
	[mm]		[mm]	[mm]	
L-WGSNP-58	58	M3	10	6	black