

L-TWK3 - Cupped Reverse Three Step Locking Circuit Board Support

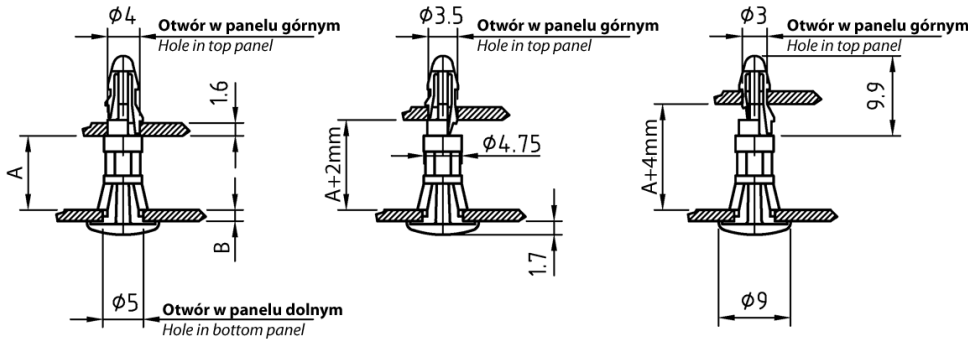

Details:

- **Material: polyamide 6.6**
- **Colour: black**
- **Height: ±0.1 mm**
- Standard pack: 100 szt.

Symbol	Height A ±0.1	Top panel thickness	Top mounting hole dia.	Top mounting hole dia.	Top mounting hole dia.	Bottom panel thickness B	Bottom mounting hole dia.	Material	Color
	[mm]	[mm]	[mm]	[mm]	[mm]	[mm]	[mm]		
L-TWK3-30-070	7	1.6	4	3.5	3	3	5	PA 66	black