

L-TDWTK - Round, pluggable stand-offs with shouldered hole

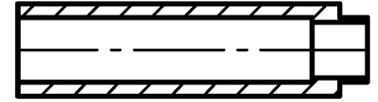
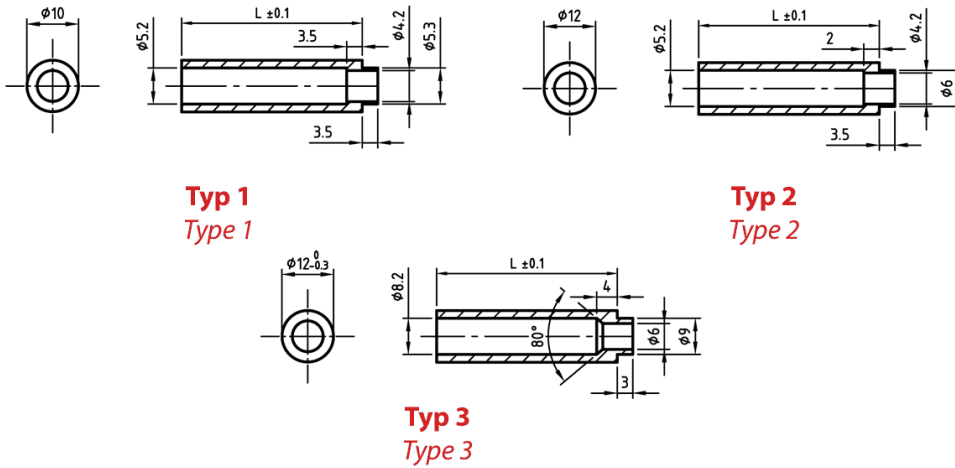

Details:

- **Material PA-GF:**
 - Glass-filled polyamide
 - Colour: black
- **Material: PS:**
 - Polystyrene
 - Colour: natural

Symbol	Height L ±0.1	Type	Material	Color
	[mm]			
L-TDWTK-3-35-NAT	35	3	PS	natural