

L-TDWTK - Round, pluggable stand-offs with shouldered hole

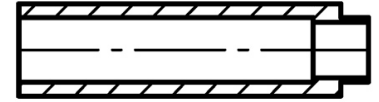
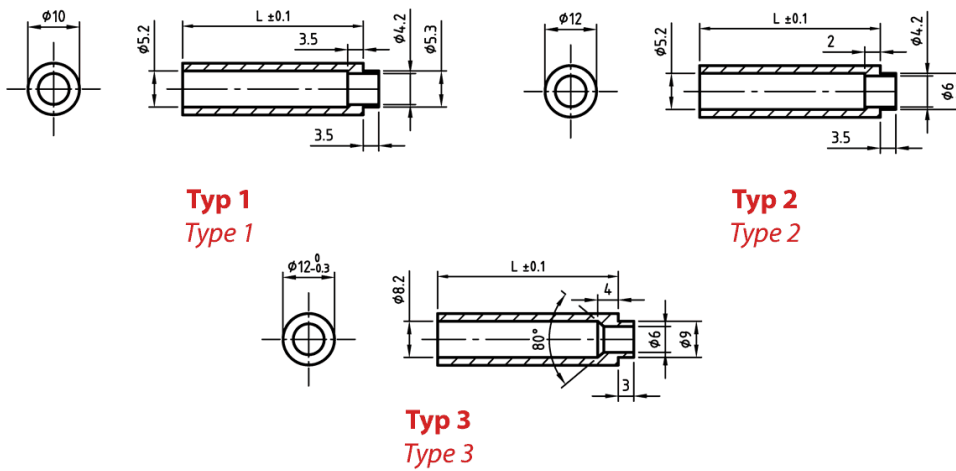

Details:

- **Material PA-GF:**
  - Glass-filled polyamide
  - Colour: black
- **Material: PS:**
  - Polystyrene
  - Colour: natural

Symbol	Height L ±0.1	Type	Material	Color
	[mm]			
L-TDWTK-2-51-NAT	51	2	PS	natural