

L-TDGFW1 - Threaded, push-in stand offs

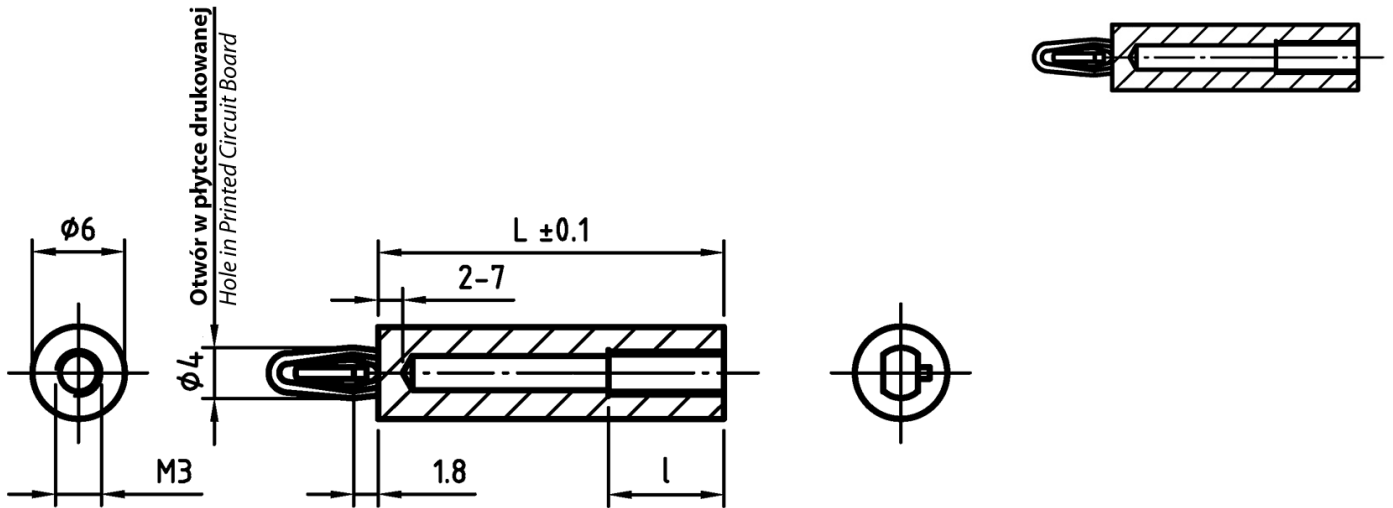

Details:

- **Material: Polyamide**
- **Colour: black**
- **Panel thickness: 1.8 mm**
- **Mounting hole: 3.2 mm**

Symbol	Height L ± 0.1	Ext. diameter	Int. thread	Int. thread length l	Grubość panelu	Mounting hole diameter	Material	Color
	[mm]	[mm]		[mm]	[mm]	[mm]		
L-TDGFW1-09	9	6	M3	7	1.8	3.2	PA 66	black