

L-TDFW1 - Plastic, push-in stand offs with hole

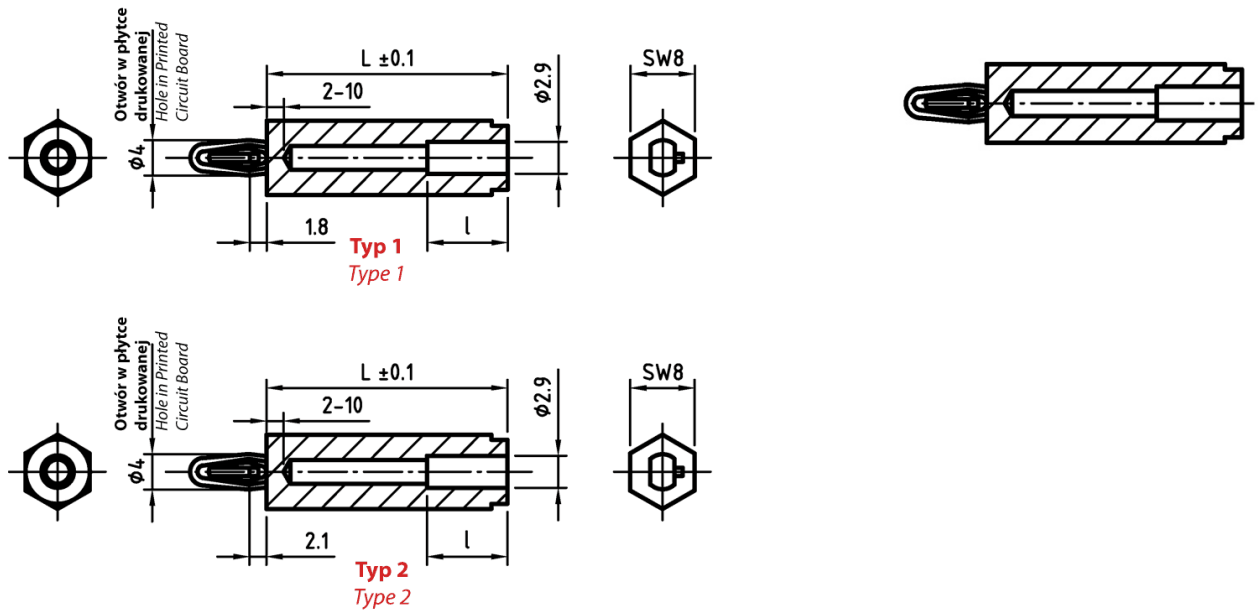

Details:

- **Material: Polyamide**
- **Colour: black**
- **Mounting hole: Ø4 mm**

Symbol	Height L ± 0.1	l	Panel thickness	Mounting hole diameter	Wrench size SW	Type	Material	Color
	[mm]				[mm]			
L-TDFW1-2-27	27	10	2	4	8	2	PA 66	black