

L-TDFW1 - Plastic, push-in stand offs with hole

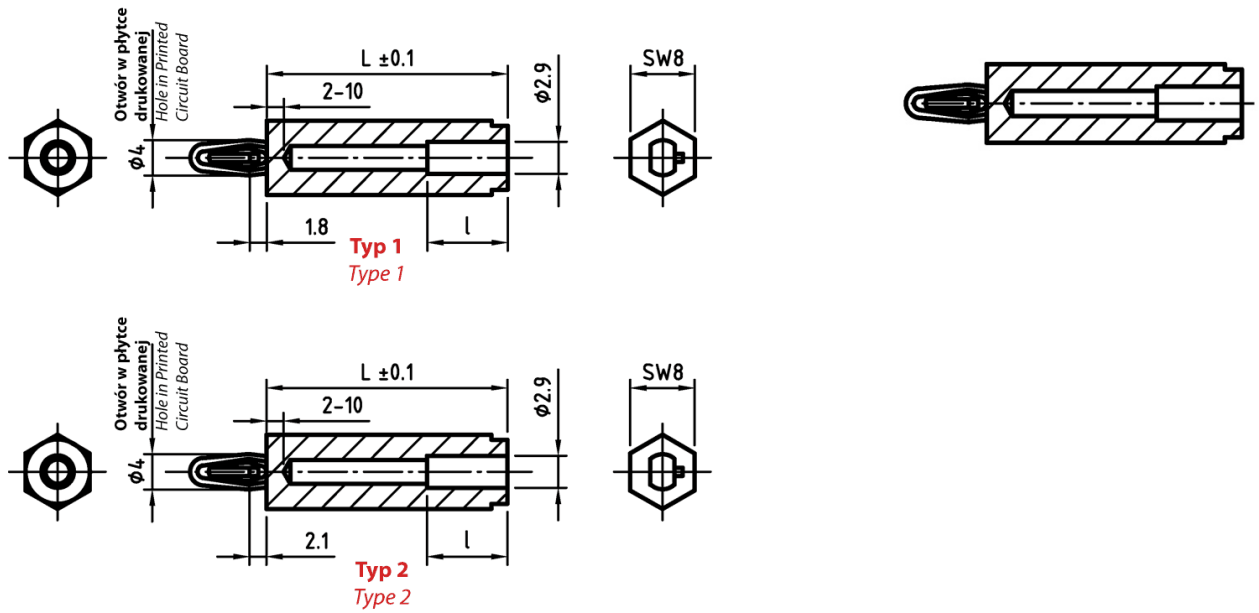

Details:

- **Material: Polyamide**
- **Colour: black**
- **Mounting hole: Ø4 mm**

Symbol	Height L ± 0.1	l	Panel thickness	Mounting hole diameter	Wrench size SW	Type	Material	Color
	[mm]							
L-TDFW1-1-42	42	10	1.6	4	8	1	PA 66	black