

## L-BHS - Cap bushing

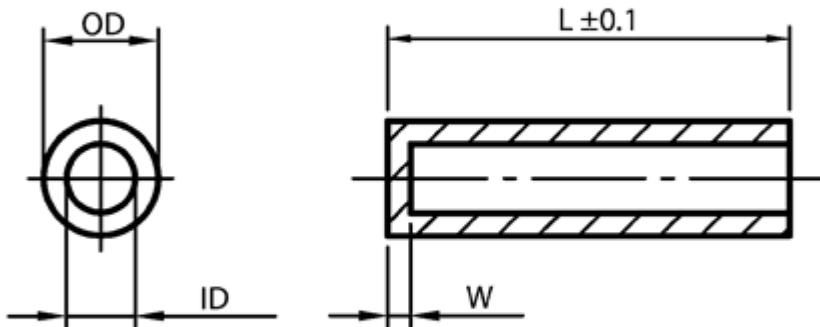

**Details:**

- **Material: PA GV - polyamide glass fiber, colour black**
- **Materiał: PS - polestyrol , colour natural**
- Standard pack: 100 pcs.

Symbol	Material	Color	Ext. diameter OD	Int. diameter ID ±0.1	Height L	W
			[mm]	[mm]	[mm]	[mm]
L-BHS-100-62-07-PA	PA+GF	black	10	6.2	7	1.5