

L-BHS - Cap bushing

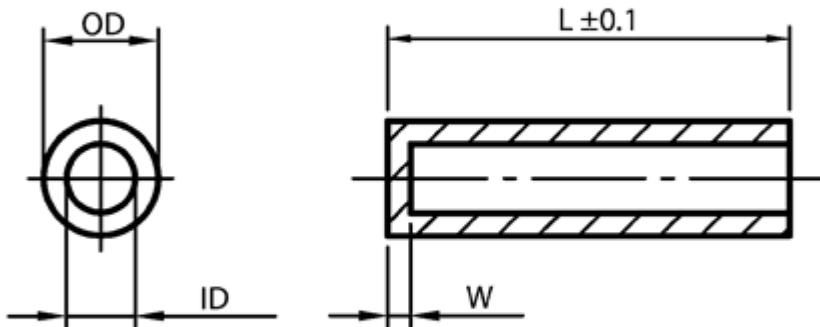

Details:

- **Material: PA GV - polyamide glass fiber, colour black**
- **Materiał: PS - polistyrol , colour natural**
- Standard pack: 100 pcs.

Symbol	Material	Color	Ext. diameter OD	Int. diameter ID ±0.1	Height L	W
			[mm]	[mm]	[mm]	[mm]
L-BHS-080-42-28-PS	PS	natural	8	4.2	28	1.5