

L-BHS - Cap bushing

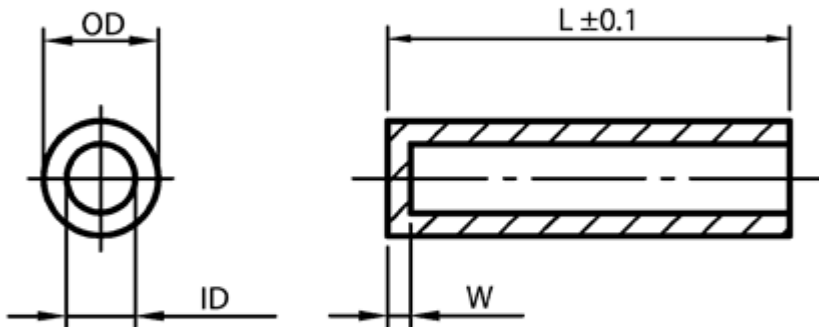

Details:

- **Material: PA GV - polyamide glass fiber, colour black**
- **Materiał: PS - polestyrol , colour natural**
- Standard pack: 100 pcs.

Symbol	Material	Color	Ext. diameter OD	Int. diameter ID ±0.1	Height L	W
			[mm]	[mm]	[mm]	[mm]
L-BHS-060-34-23-PA	PA+GF	black	6	3.4	23	1.3