

KSLSP-1 - Key Slot Locking Support Post

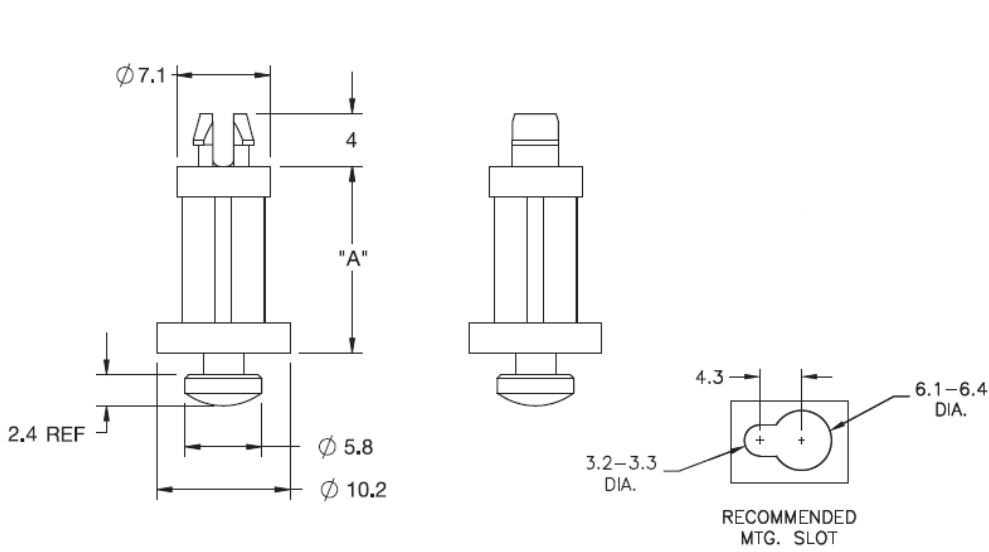

Details:

- **Material: Nylon 6/6, UL 94 V-2, RMS-01***
- **Material: Nylon 6/6, UL 94 V-0, RMS-19***
- **Color: natural**
- **Standard pack: 1000 pcs**

Symbol	Height A ±0.4	Top mounting hole dia. ±0.08	Top panel thickness	Bottom panel thickness	Material	Flammability	Color
	[mm]	[mm]	[mm]	[mm]			
KSLSP1-8-19	12.7	4	1.57	1.57	PA 66	UL94 V-0	natural