

IP-BBS-1218 - Cylindrical PU adhesive bumpers

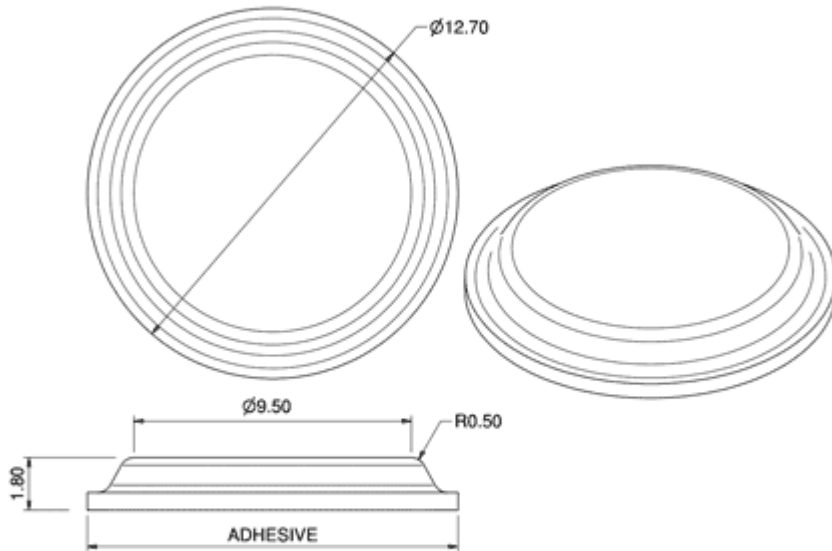

Details:

- **Material: polyurethane**
- **Colour: transparent or black.** On special order: white, grey or brown
- Standard pack: see table
- Tolerance: ± 0.25 mm

Symbol	Base diameter W	Height H	Color	Standard pack
	[mm]	[mm]		[szt./pcs]
IP-BBS-1218-CL	12.7	1.8	clear	200