

HTSMG-2 - Hexagonal Mild Steel Standoff

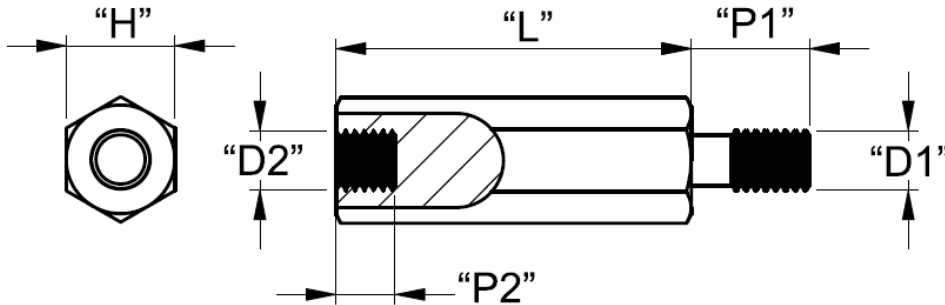

Details:

- Brass, nickel plated RMS-232*
- Available lengths in 1mm increments in given ranges
- Standard pack: 100/Baf

Symbol	Ext. thread D1	Int. thread D2	Length L	Wrench size H	Ext. thread length P1	Int. thread length P2	Material
			[mm]	[mm]	[mm]	[mm]	
HTSMG-M5-14-8-2	M5	M5	14	8	8	8	steel, zinc plated