

HTSMG-1 - Hexagonal Mild Steel Standoff

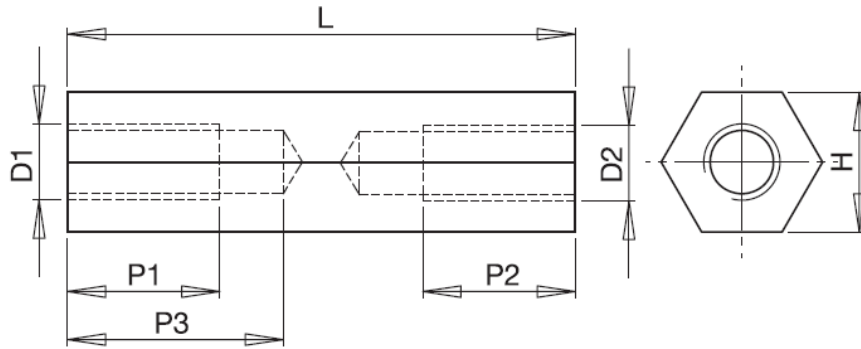

Details:

- **Material: Steel, zinc plated RMS-232***
- **Standard pack: 100 pcs**

Symbol	Int. thread D1=D2	Length L	Wrench size H	Int. thread length P1=P2	Material
		[mm]	[mm]	[mm]	
HTSMG-M4-98-8-1	M4	98	8	10	steel, zinc plated