

## HTSMG-2 - Hexagonal Mild Steel Standoff

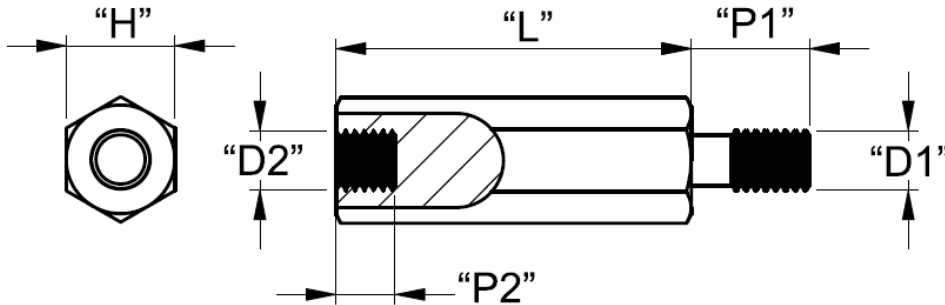

Details:

- Brass, nickel plated RMS-232\*
- Available lengths in 1mm increments in given ranges
- Standard pack: 100/Baf

Symbol	Ext. thread D1	Int. thread D2	Length L	Wrench size H	Ext. thread length P1	Int. thread length P2	Material
			[mm]	[mm]	[mm]	[mm]	
HTSMG-M4-36-7-2	M4	M4	36	7	8	10	steel, zinc plated