

HTSMG-2 - Hexagonal Mild Steel Standoff

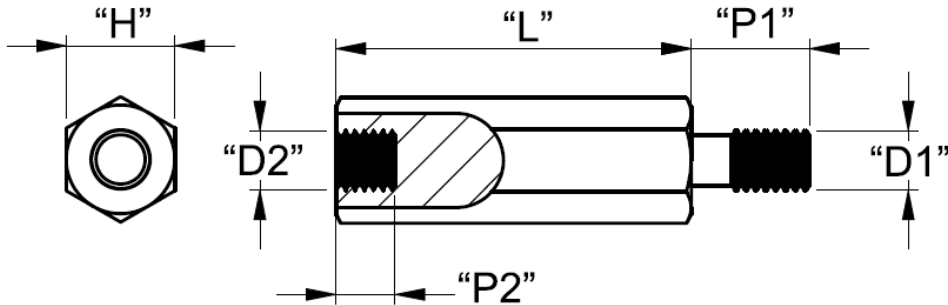

Details:

- **Brass, nickel plated RMS-232***
- **Available lengths in 1mm increments in given ranges**
- **Standard pack: 100/Baf**

Symbol	Ext. thread D1	Int. thread D2	Length L	Wrench size H	Ext. thread length P1	Int. thread length P2	Material
			[mm]	[mm]	[mm]	[mm]	
HTSMG-M3-74-5.5-2	M3	M3	74	5.5	6	10	steel, zinc plated