

HTSMG-1 - Hexagonal Mild Steel Standoff

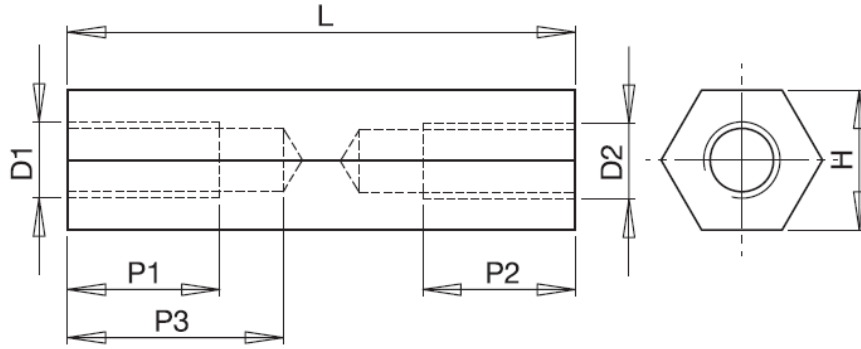

Details:

- **Material: Steel, zinc plated RMS-232***
- **Standard pack: 100 pcs**

| Symbol | Int. thread D1=D2 | Length L | Wrench size H | Int. thread length P1=P2 | Material |
|-----------------|----------------------|-------------|------------------|-----------------------------|--------------------|
| | | [mm] | [mm] | [mm] | |
| HTSMG-M3-19-5-1 | M3 | 19 | 5 | 19 | steel, zinc plated |