

H-LTSCG - Liquid Tight Cordgrips

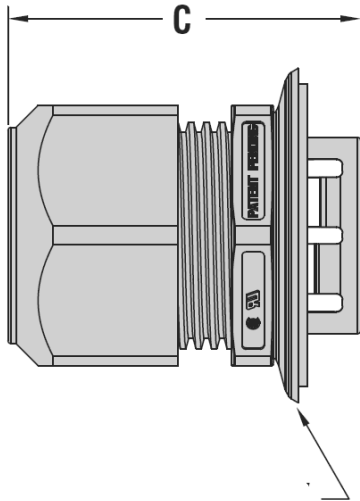

Uszczelka / kołnierz uszczelniający
Sealing flange/washer construction

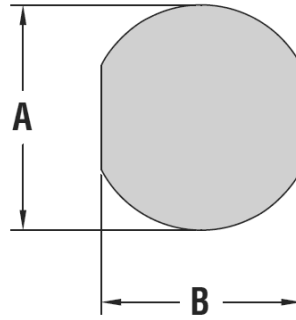

Sugerowany otwór do montażu bezgwintowego
Suggested clearance hole for nonthreaded mounting



Details:

- **Body material:** Nylon 6/6
- **Washer material:** TPR lub NBR
- **Colour:** black
- Ingress protection: IP65
- Easy installation - securely snap into a range of panel thicknesses - up 3,2 mm - with no tools or locknuts required.
- Sealing flange prevents sealing washer displacement due to water velocity to ensure a liquid tight IP 65 seal.
- Eliminate need for locknut or threaded hole to achieve liquid tight seal at panel; perfect for low clearance installation where locking nut access is limited.
- Ratchet design of sealing nut assembly provides superior antivibration and ensures a firm grip on the cable.
- Foam washer included.
- Rotation prevented when used in Double D mounting holes.
- We recommend using the fitting with the smallest maximum diameter that will fit your application.

Symbol	Mounting hole dimentions A x B	C	Cable diameter range	Material	Color
	[mm]	[mm]	[mm]		
H-M3844	31.8 x 28.6	52.1	12.4 - 20.0	PA 66	black