

**H-SLP -**

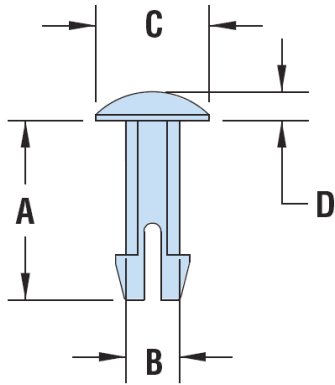

**Typ 1**  
Type 1

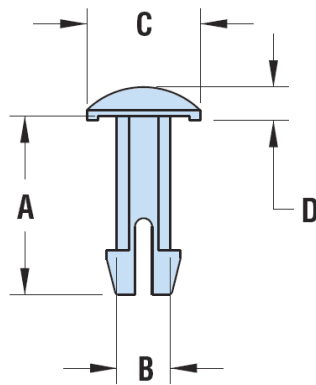

**Typ 2**  
Type 2



Details:

- **Material: Nylon 6/6**
- **Klasa palności: UL94 V-2**
- Zakres temperatur: -40°C do 85°C
- Used to fix connectors to the printed circuit board prior to wave soldering.

Symbol	Mounting hole diameter	Panel thickness	A	B	Head diameter C	Head height D	Type	Material	Flammability	Color
	[mm]		[mm]	[mm]	[mm]	[mm]				
H-12054	2.5	6.2	8.1	2.4	5.1	1.5	2	PA 66	UL94 V-2	natural