

H-HMSPDL - Nylon PCB Supports

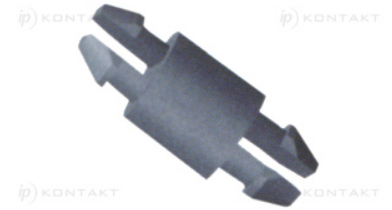
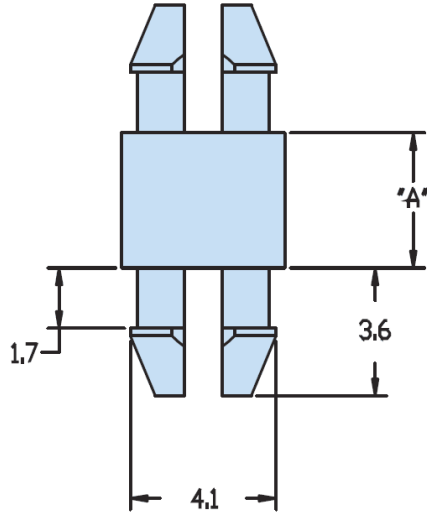

Details:

- **Material: Nylon 6/6 UL94 V-2**
- **UL94 V-0 available on special order**
- **Temperature Range: -40°C to 85°C**
- Dimension A = height
- Dimensions: ±0.1 mm

Symbol	Height A	Top mounting hole dia.	Top panel thickness	Bottom mounting hole dia.	Bottom panel thickness	Material	Flammability	Color
	[mm]	[mm]	[mm]	[mm]	[mm]			
H-10302	4.8	3.9	1.6	3.9	1.6	PA 66	UL94 V-2	natural