

H-HLSP7 - Nylon PCB Support

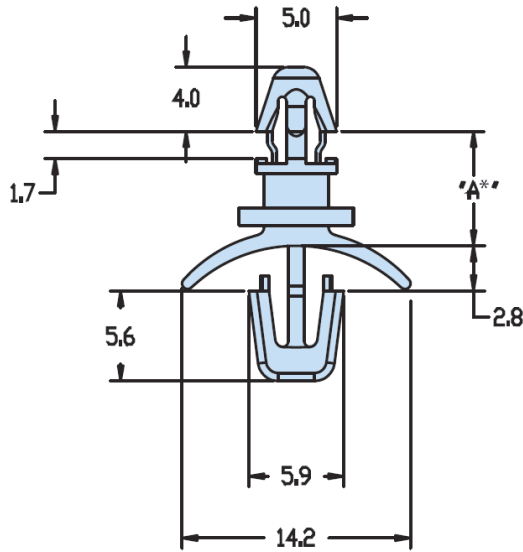

Details:

- **Material Nylon 6/6 UL94 V-2**
- **UL94 V-0 available on special order**
- **Temperature Range: -40°C to 85°C**
- Dimension A = height to top of PCB
- Dimensions: ±0.1 mm

Symbol	Height A	Top mounting hole dia.	Top panel thickness range	Bottom mounting hole dia.	Bottom panel thickness range	Material	Flammability	Color
	[mm]	[mm]	[mm]	[mm]	[mm]			
H-10136	11.1	4	1.6 max.	4.8	2.0 max.	PA 66	UL94 V-2	natural