

H-PF - Nylon Push-In fasteners

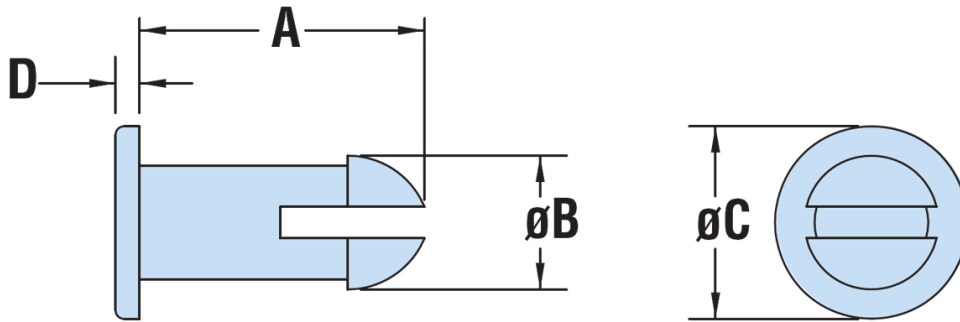

Details:

- **Material: Nylon 6/6**
- **Colour: natural or black**
- Flammability Rating: UL94 V-2
- Temperature Range: 0°C to 85°C

Symbol	Panel thickness	Mounting hole diameter	A	ØB	Head diameter ØC	Head height D	Material	Flammability	Color	Notes
	[mm]	[mm]	[mm]	[mm]	[mm]	[mm]				
H-0358B	3.1	5.1	6.9	6.1	11.9	1.3	PA 66	UL94 V-2	black	-