

H-PF - Nylon Push-In fasteners

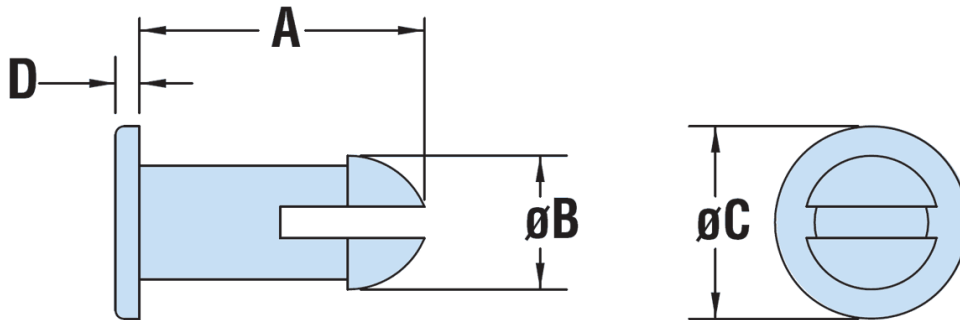

Details:

- **Material:** Nylon 6/6
- **Colour:** natural or black
- Flammability Rating: UL94 V-2
- Temperature Range: 0°C to 85°C

Symbol	Panel thickness	Mounting hole diameter	A	ØB	Head diameter ØC	Head height D	Material	Flammability	Color	Notes
	[mm]	[mm]	[mm]	[mm]	[mm]	[mm]				
H-0335	22.4	6.3	28.5	7.1	9.7	1.5	PA 66	UL94 V-2	natural	-