

G-ODB - Pull Mount Bumper

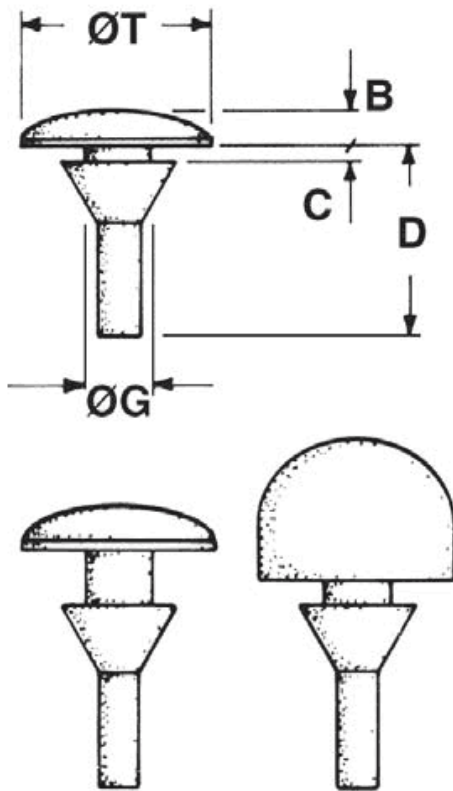

G-ODB-725

Details:

- **Material: Silicone Rubber, 65 Shore A, RMS-321***
- **Standard Pack: 1000/Bag**

Symbol	Head diameter ØT	Head height B	Panel thickness C	D	Mounting hole diameter ØG	Material	Color
	[mm]	[mm]	[mm]	[mm]	[mm]		
G-ODB-725-2	12	8	1.5	18	5	silicone rubber	black