

FTH-34/35 - Flat Tie Holder, Screw Mount

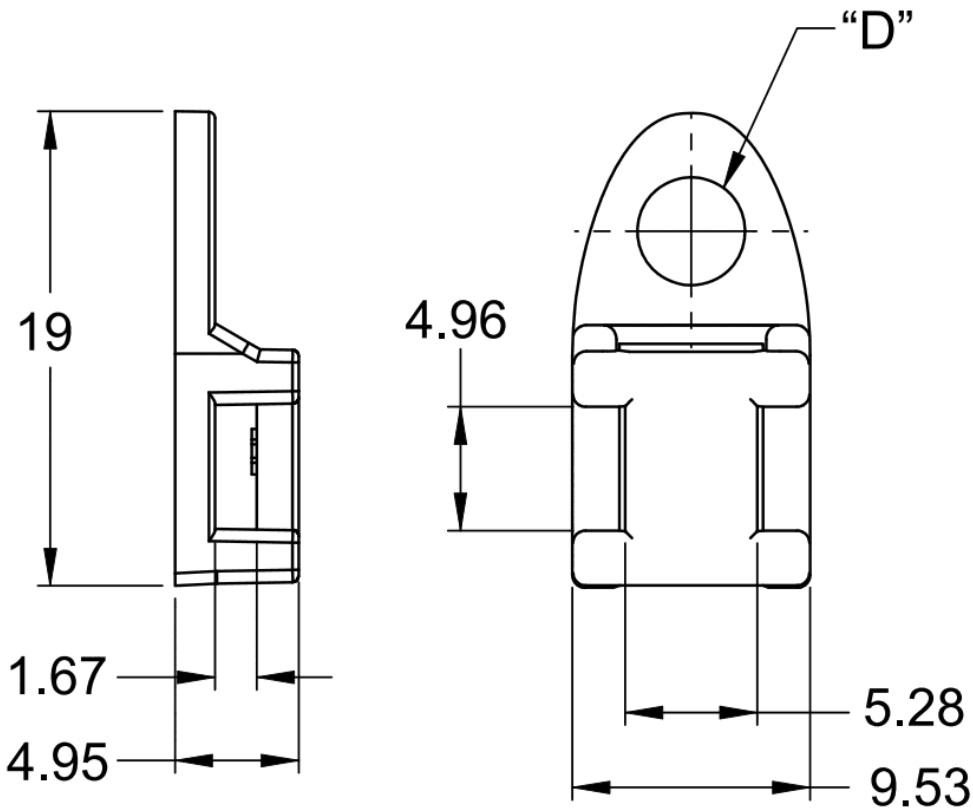

Details:

- **Material:**
 - Flammability UL94 V-2: Nylon 6/6
 - Flammability UL94 V-0: Nylon 6/6 F.R.
- **Color: natural**
- **To be used with cable ties: WITE-18, -30, -40, -50, -60**
- **RoHS compliant**
- Standard packaging: 1000 pcs

Symbol	D	Screw	Flammability	Working temperature
	[mm]			[°C]
FTH-35-01	5.1	M5	UL94 V-2	-40 - 85