

## FSR - Foot, Snap Rivet Mount

**Rys. 1**

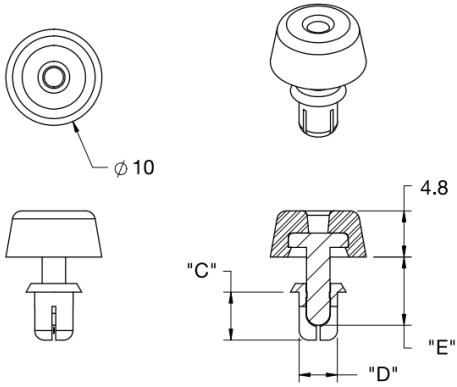

**Rys. 2**

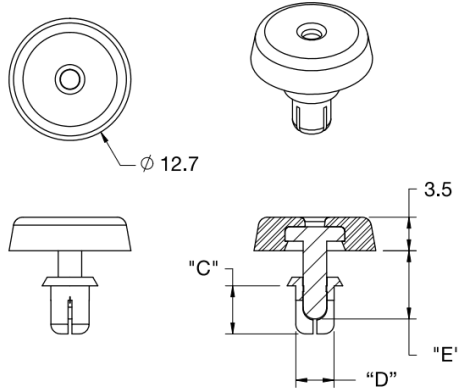

**Otwór montażowy**

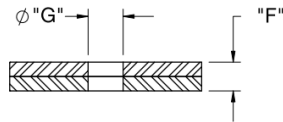

**Details:**

- **Material: Rivet: UL94 V2 Nylon 6, RMS-52\***
- **Foot: TPE, RMS-351\***
- **Color: Black**
- **Standard Pack: 1000/Bag**

Symbol	Mounting hole diameter range G	Panel thickness range F	C	D	E	Fig.	Material	Color
	[mm]	[mm]	[mm]	[mm]	[mm]			
FSR-6	4.1 - 4.2	2.5 - 3.5	5	4	7.1	2	TPE	black