

FSR - Foot, Snap Rivet Mount

Rys. 1

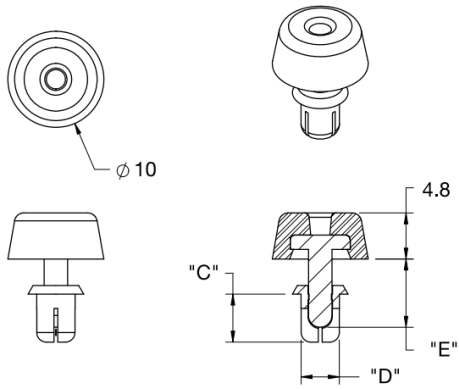

Rys. 2

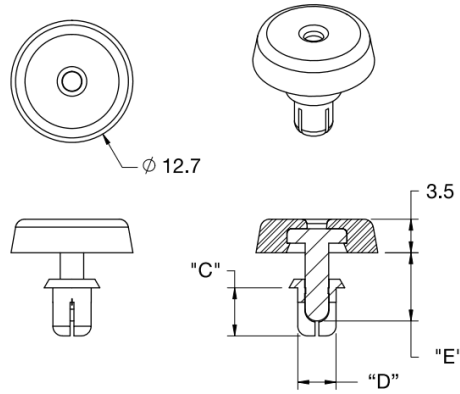

Otwór montażowy

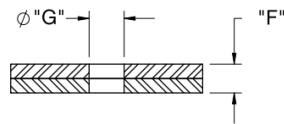

Details:

- **Material: Rivet: UL94 V2 Nylon 6, RMS-52***
- **Foot: TPE, RMS-351***
- **Color: Black**
- **Standard Pack: 1000/Bag**

Symbol	Mounting hole diameter range G	Panel thickness range F	C	D	E	Fig.	Material	Color
	[mm]	[mm]	[mm]	[mm]	[mm]			
FSR-4	3.6 - 3.7	1.2 - 2.1	3.5	3.5	5.1	2	TPE	black