

**DSM/DSB - D Sub Miniature Standoff**

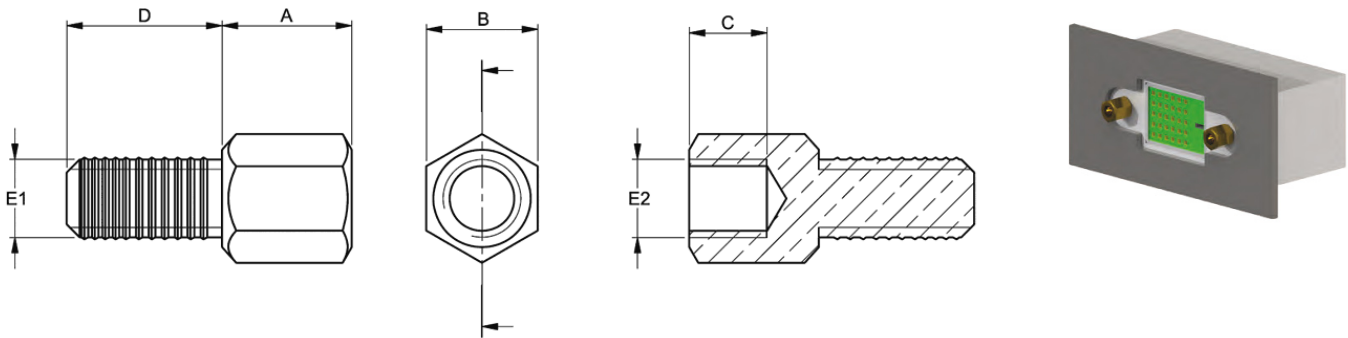

Details:

- **Material:**
  - **Brass. RMS-276\* Nickel Plating. RMS-234\***
  - **Mild Steel. RMS-237\* Nickel Plating. RMS-235\***
- Standard pack: 100/Bag

Symbol	Ext. thread E1	Int. thread E2	Length A	Wrench size B	Int. thread length C	Ext. thread length D	Material
			[mm]	[mm]	[mm]	[mm]	
DSB-308204040050	#4-40	#4-40	5	5	3.5	8	brass, nickel plated