

DSM/DSB - D Sub Miniature Standoff

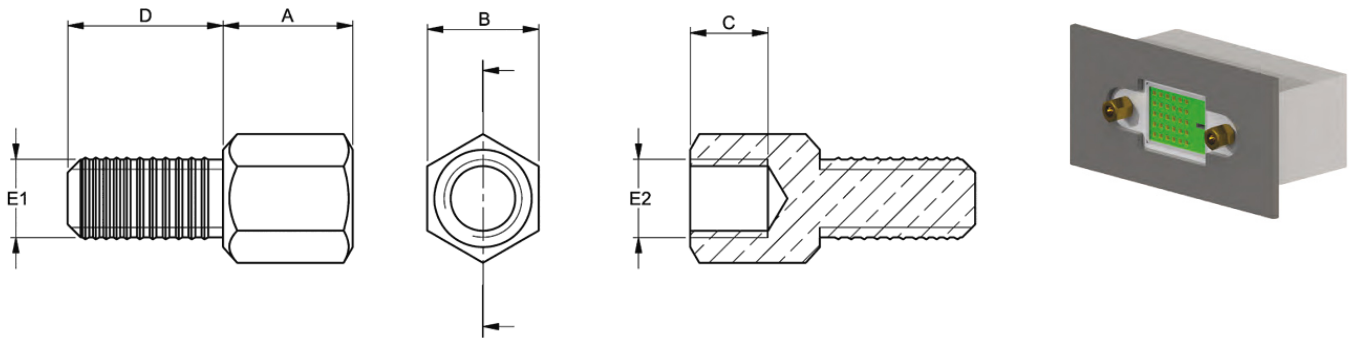

Details:

- **Material:**
 - **Brass. RMS-276* Nickel Plating. RMS-234***
 - **Mild Steel. RMS-237* Nickel Plating. RMS-235***
- Standard pack: 100/Bag

Symbol	Ext. thread E1	Int. thread E2	Length A	Wrench size B	Int. thread length C	Ext. thread length D	Material
			[mm]	[mm]	[mm]	[mm]	
DSB-308202040050	M3	#4-40	5	5	3	8	brass, nickel plated