

DLCBS - Nylon Dual Locking Circuit Board Support

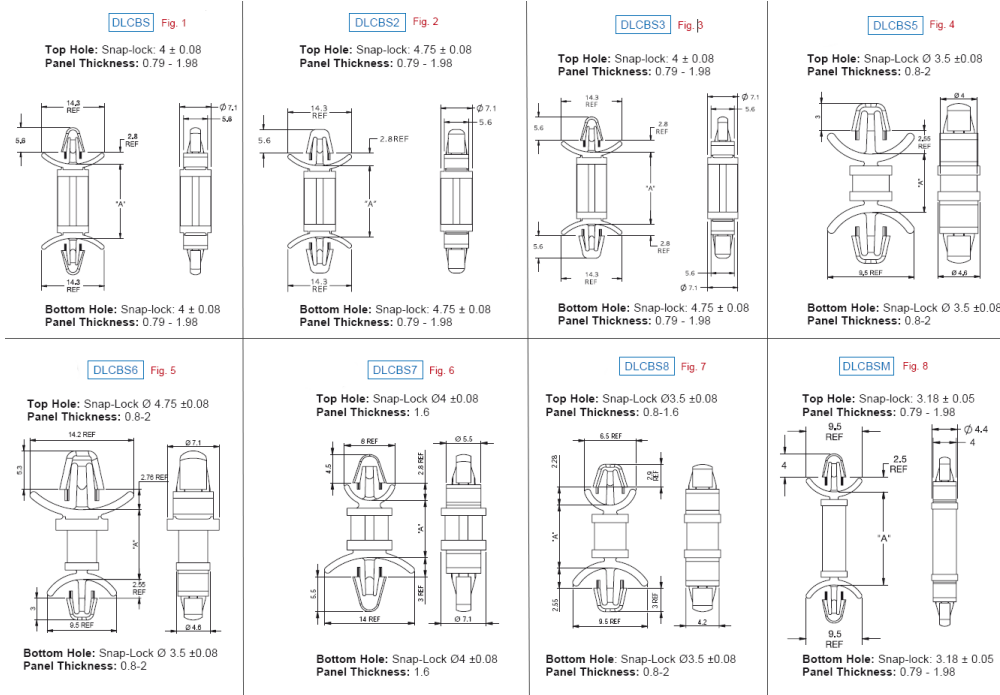

Details:

- **Material:** Nylon 6/6, UL 94 V-2, RMS-01*
- **Material:** Nylon 6/6, UL 94 V-0, RMS-19*
- **Color:** natural
- Standard pack: 1000 pcs

Symbol	Height A	Top mounting hole dia. ± 0.08	Top panel thickness range	Bottom mounting hole dia. ± 0.08	Bottom panel thickness range	Material	Flammability	Color
	[mm]	[mm]	[mm]	[mm]	[mm]			
DLCBS5-8-19	12.7	3.5	0.8 - 2	3.5	0.8 - 2	PA 66	UL94 V-0	natural