

D-MS-3 - Polyamid hexagonal spacer bolt with brass thread

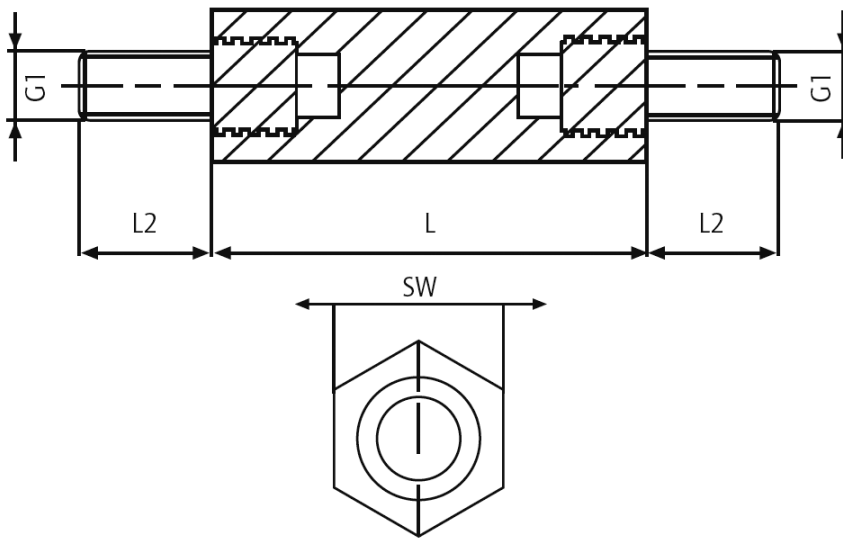

Details:

- **Body Material: Polyamide 6.6**
- **Color: white**
- **Thread inserts: brass (Nickel-plated on special order)**
- Fire rating: UL94 V-2
- Contact resistance DIN 53482: $>10^{12} \Omega/cm$
- Dielectric strength DIN 54481: 50kV/mm
- Length tolerance: $\pm 0.1mm$
- Pull-out force and torque values may vary depending on application and ambient influences like temperature, air humidity etc.

Symbol	Ext. thread G1	Wrench size SW	Length L	Ext. thread length L2	Max. torque [Nm]	Pull out force [N]	Material
		[mm]	[mm]	[mm]			
D-MS-3-M3-6-41	M3	6	41	8	1.3	300	PA 66, brass