

**D-HTSP-2 - Polyamid hexagonal spacer bolt with brass thread**

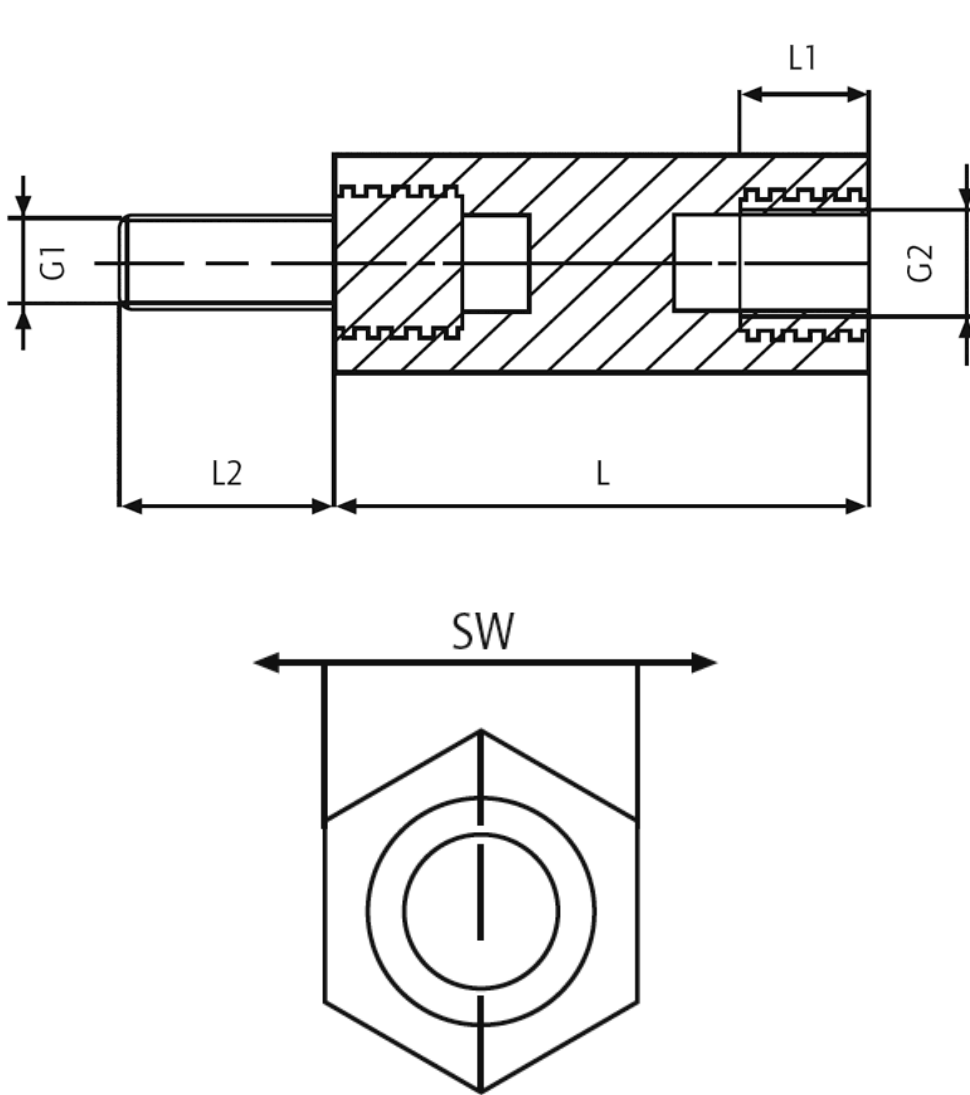

- Details:
- **Body material: Polyamide 6.6**
  - **Colour: natural**
  - Thread inserts: bare brass
  - Temperature resistance: up to 110°C
  - Fire class: UL 94-V2
  - Contact resistance:  $10^{12}$  Ohm/cm
  - Dielectric strength: 50kV/mm
  - Tolerance for length dimensions:  $\pm 0.2$  mm

Symbol	Int. thread G2	Ext. thread G1	Wrench size SW	Int. thread length L1	Ext. thread length L2	Length L	Max. torque	Pull out force	Material
			[mm]	[mm]	[mm]				
D-HTSP-2-M8-15-39	M8	M8	15	11	14	39	18	1600	PA 66, brass

**Notice!**The pull-out strength and torques may vary depending on application and ambient influences (e.g. temperature, air humidity, etc.). For critical applications please carry out trials. Producer does not assume any liability for the specified strength values.