

D-HTSP-1 - Polyamid hexagonal spacer bolt with brass thread

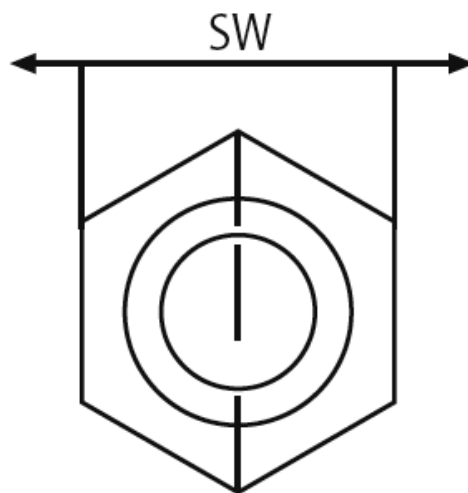
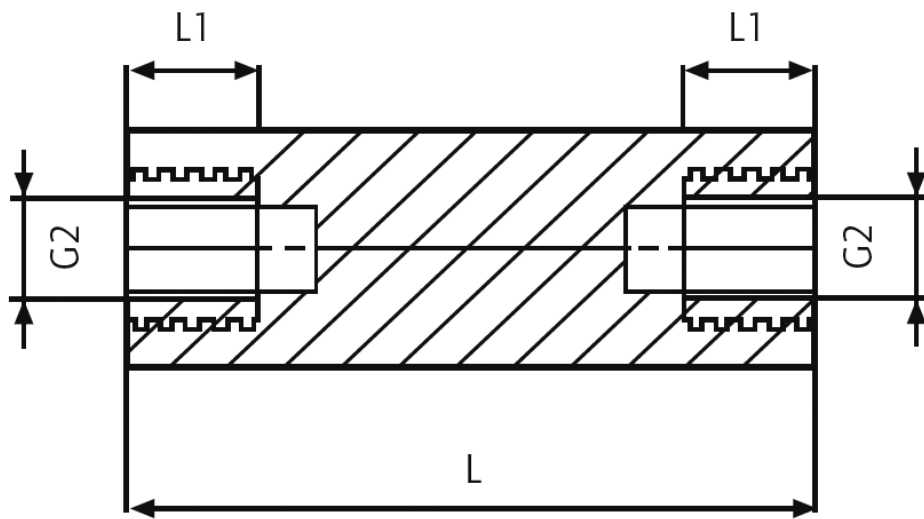

Details:

- **Body material: Polyamide 6.6**
- **Colour: natural**
- **Thread inserts: bare brass**
- Temperature resistance: up to 110°C
- Fire class: UL 94-V2
- Contact resistance: 10^{12} Ohm/cm
- Dielectric strength: 50kV/mm
- Tolerance for length dimensions: ± 0.2 mm

| Symbol | Int. thread G2 | Wrench size SW | Int. thread length L1 | Length L | Max. torque | Pull out force | Material |
|-------------------|----------------|----------------|-----------------------|----------|-------------|----------------|--------------|
| | | [mm] | [mm] | [mm] | [Nm] | [N] | |
| D-HTSP-1-M8-15-90 | M8 | 15 | 11 | 90 | 18 | 1600 | PA 66, brass |

Notice!The pull-out strength and torques may vary depending on application and ambient influences (e.g. temperature, air humidity, etc.). For critical applications please carry out trials. Producer does not assume any liability for the specified strength values.