

D-HT-2 - Polyamid hexagonal spacer bolt

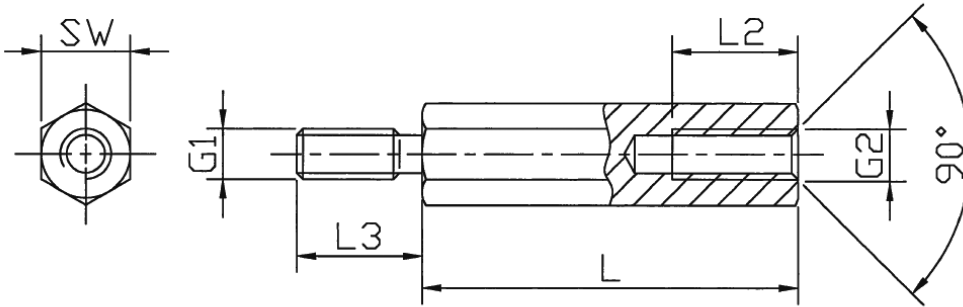

Details:

- **Material: Polyamide 66, color: black**
- **Length tolerance: ± 0.1mm**
- **Standard pack: 500 pcs**

Symbol	Height L	Int. thread G2	Int. thread length L2	Ext. thread G1	Ext. thread length L3	Wrench size SW	Material	Color
	[mm]		[mm]		[mm]			
D-HT-2-M4-8-43-WH/7	43	M4	10	M4	7	8	PA 66	white