

D-HT-2 - Polyamid hexagonal spacer bolt

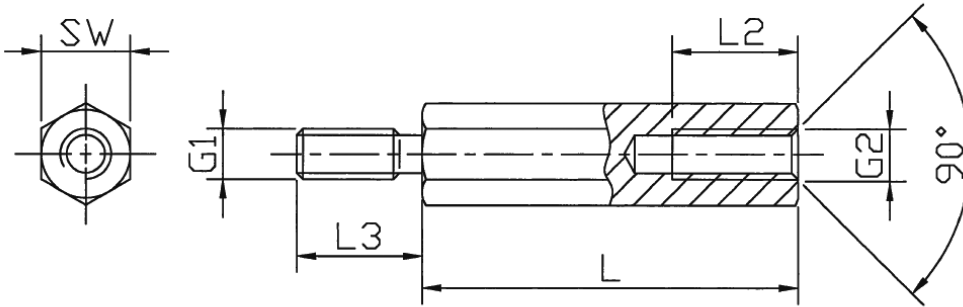

Details:

- **Material: Polyamide 66, color: black**
- **Length tolerance: ± 0.1mm**
- **Standard pack: 500 pcs**

Symbol	Height L	Int. thread G2	Int. thread length L2	Ext. thread G1	Ext. thread length L3	Wrench size SW	Material	Color
	[mm]		[mm]		[mm]			
D-HT-2-M3-6-7-WH/6	7	M3	5	M3	6	6	PA 66	white