

D-HSPA - Polystyrene cap nut, cap screw

Rys. 1

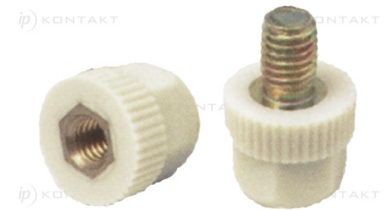

Rys. 2

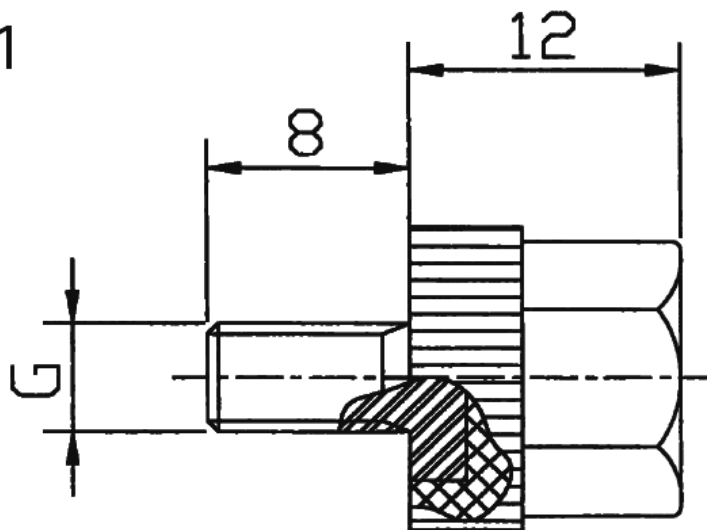
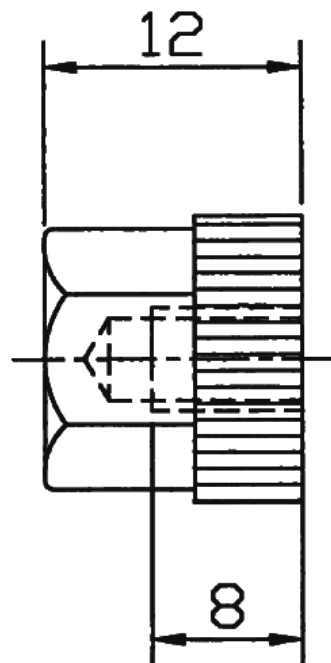

Details:

- **Body: polystyrene, gray (other colors on special order)**
- **Threaded insert: galvanized steel**
- **Working temperature to: 90°C**
- **Fire rating: UL 94-V2**
- **Contact resistance: DIN 53482: >1016 Ω/cm**
- **Dielectric strength: min. 5000V**
- **Length tolerance: ± 0.5mm**

Symbol	Typ	Rys.	Material	Int. thread	Ext. thread	Int. thread length	Ext. thread length	Length
						[mm]	[mm]	[mm]
D-HSPA-55M-M5	screw	1	PS, stal	-	M5	-	8	12