

D-HSP-2 - Polystyrene spacer bolt with steel thread

Typ: okrągły

Gwint: zewn. / zewn.

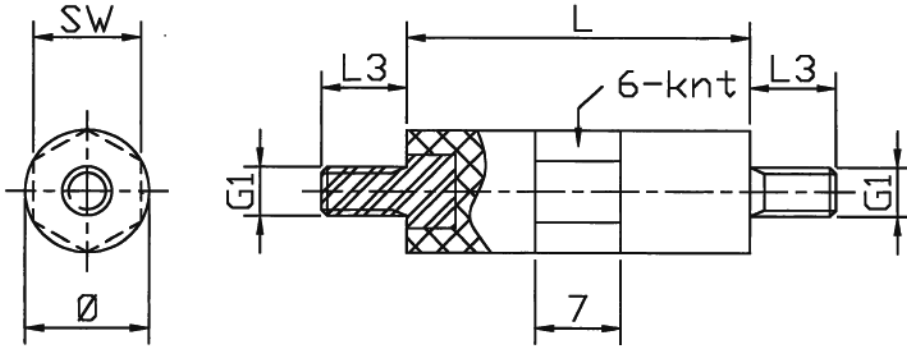

Typ: sześciokątny

Gwint: zewn. / zewn.

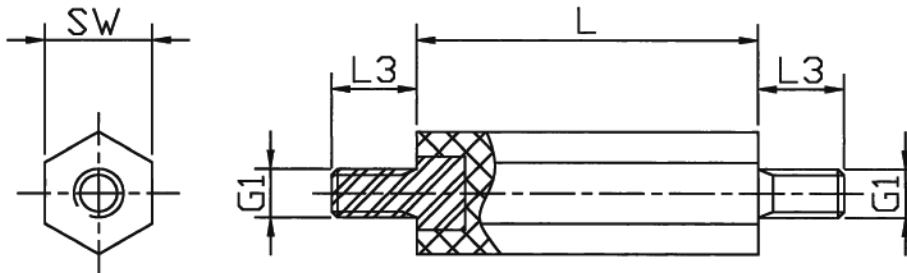

Details:

- Body: polystyrene, gray (other colors on special order)
- Threaded insert: galvanized steel
- Working temperature to: **90°C**
- Fire rating: **UL 94-V2**
- Contact resistance: **DIN 53482: >10¹⁶ Ω/cm**
- Dielectric strength: **min. 5000V**
- **Length tolerance: ± 0.5mm**

Symbol	Typ	Diameter	Wrench size	Ext. thread	Ext. thread length	Length	Material
		Ø	SW		G1		
		[mm]	[mm]			[mm]	
D-HSP-2-M4-9-10	round	10	9	M4	7	10	PS, galvanized steel