

D-HSP-1 - Polystyrene spacer bolt with steel thread

Typ: okrągły.

Gwint: wewn. / zewn.

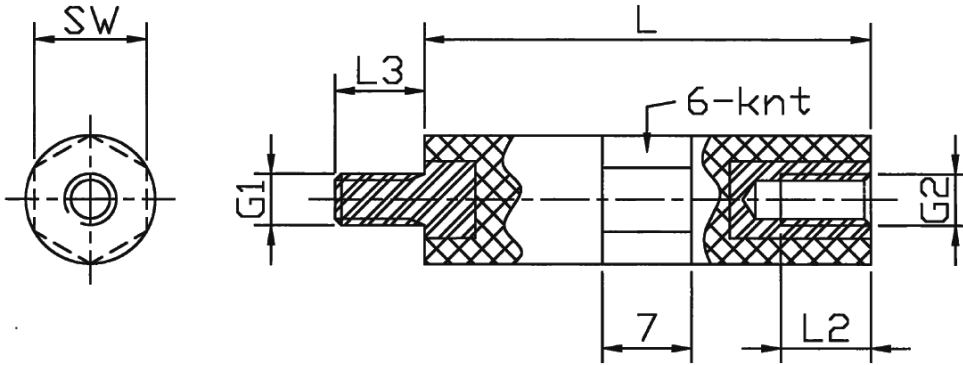

Typ: sześciokątny

Gwint: wewn. / zewn.

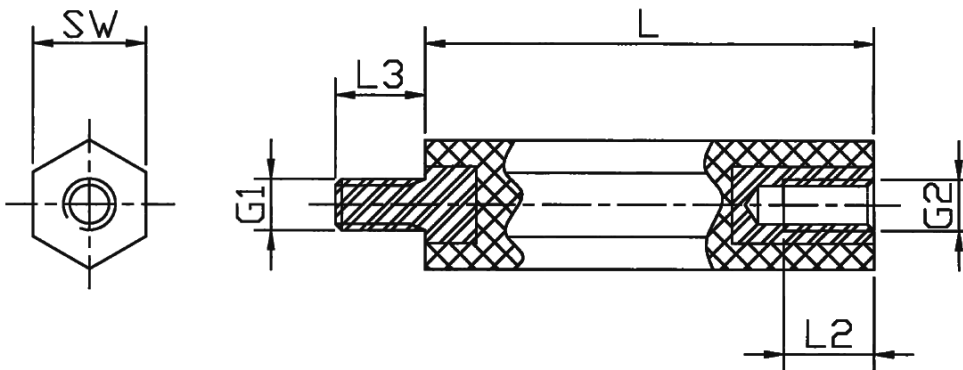

Details:

- Body: polystyrene, gray (other colors on special order)
- Threaded insert: galvanized steel
- Working temperature to: **90°C**
- Fire rating: **UL 94-V2**
- Contact resistance: **DIN 53482: >10¹⁶ Ω/cm**
- Dielectric strength: **min. 5000V**
- **Length tolerance: ± 0.5mm**

Symbol	Typ	Diameter	Wrench size SW	Ext. thread G1	Int. thread G2	Int. thread length L2	Ext. thread length L3	Length L	Material
		[mm]	[mm]			[mm]	[mm]	[mm]	
D-HSP-1-M6-13-15	hexagonal	-	13	M6	M6	7	7	15	PS, galvanized steel