

D-HB-2 - Brass hexagon spacer with nickel plating

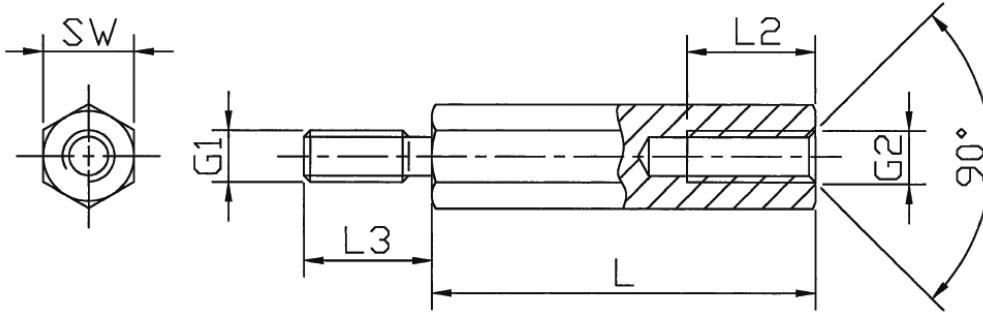

Details:

- **Material: brass acc. to DIN 17660: Cu Zn 39 Pb 3**
- **Min. tensile strength: 430 N/mm²**
- **Surface finish acc. to: DIN 267: nickel plated (G 3 E)**
- **Tolerance for length dimension: ±0.1mm**
- **Also available w/o undercut**
- **RoHS compliant**
- **Standard pack: 100 pcs.**

Symbol	Ext. thread G1	Int. thread G2	Wrench size SW	Length L	Int. thread length L2	Ext. thread length L3	Material
			[mm]	[mm]	[mm]	[mm]	
D-HB-2-M2.5-5-60	M2.5	M2.5	5	60	10	6	brass, nickel plated