

BL-SMM50 - Wing screws

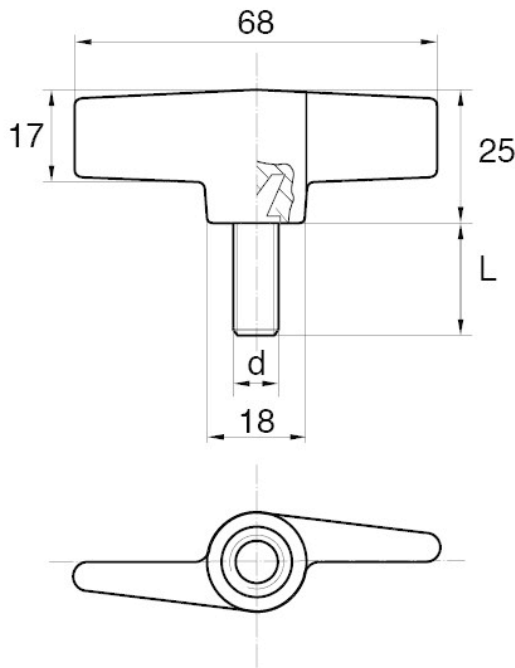

Details:

- **Handle material:** Nylon
- **Stud material:** Zinc-plated steel; Stainless steel or brass available on special order
- **Handle colour:** black; other colours available on special order
- Optional cover available
- M10 screws available on special order

Symbol	Ext. thread d	Ext. thread length L	Standard pack
		[mm]	[szt./pcs]
BL-SMM50-M6-50	M6	50	5000