

BL-SMM20 - Wing screws

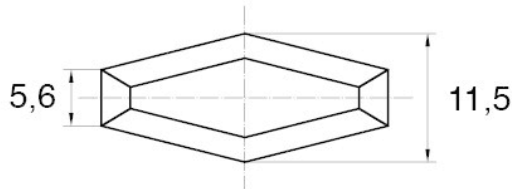
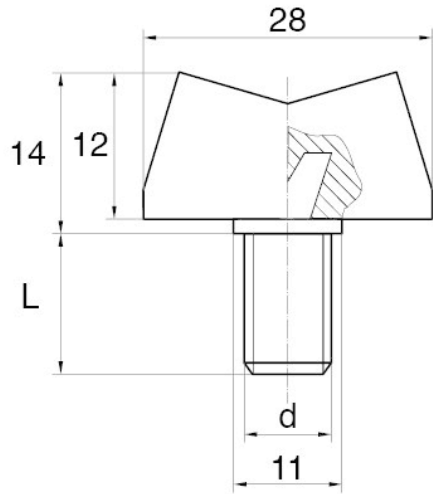

Details:

- **Handle material:** Nylon
- **Stud material:** Zinc-plated steel; Stainless steel or brass available on special order
- **Handle colour:** black; other colours available on special order
- Other lengths available on special order

Symbol	Thread d	Ext. thread length L	Standard pack
		[mm]	[szt./pcs]
BL-SMM20-M6-20	M6	20	2500