

BL-SMM20 - Wing screws

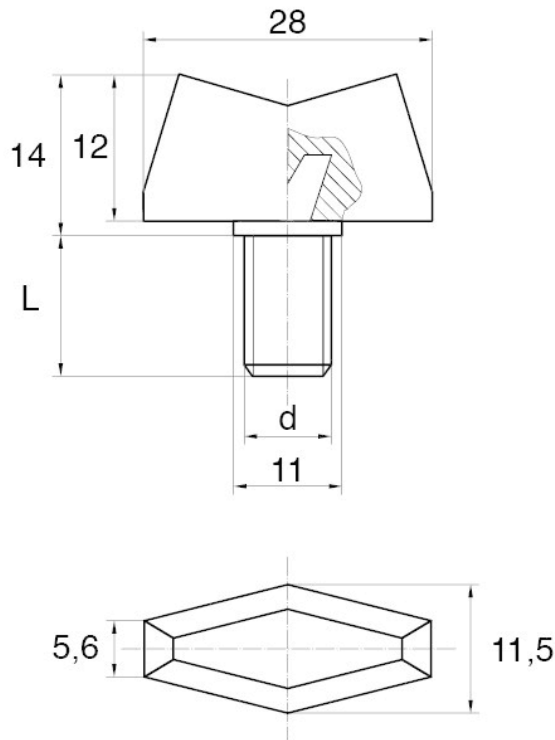

Details:

- **Handle material:** Nylon
- **Stud material:** Zinc-plated steel; Stainless steel or brass available on special order
- **Handle colour:** black; other colours available on special order
- Other lengths available on special order

Symbol	Thread d	Ext. thread length L	Standard pack
		[mm]	[szt./pcs]
BL-SMM20-M5-25	M5	25	2500