

BL-SLP12 - Flat head slotted screws D12

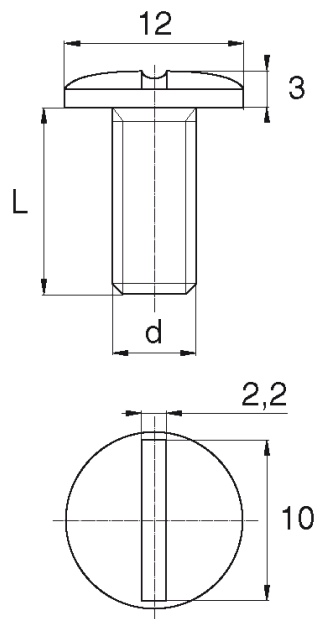

Details:

- **Material: Nylon**
- **Colour: natural**
- Materials: Nylon glass filled, PP, PE, PVDF, PC available on special order
- Other colours available on special order
- Washer faced head screw on special order
- Lengths 15 and 17 mm have a 5.0 mm non-threaded part under the head
- The dimension M4x30 has a 5.0 mm non-threaded part under the head
- Most screws fully threaded up to 80 mm long
- Head diameter: 12.0 mm

Symbol	Thread d	L	Head diameter	Head height	Material	Color	Standard pack
		[mm]	[mm]	[mm]			[szt./pcs]
BL-SLP12-M8x85	M8	85	12	3	PA	natural	5000