

**BL-PZPW-3 - Anti-loss washers**

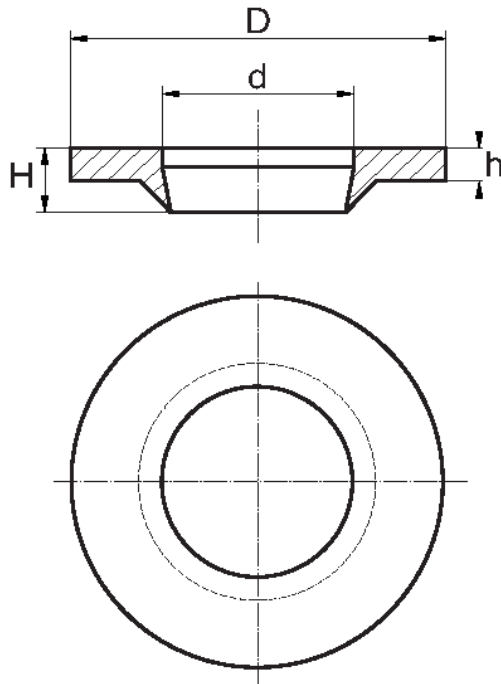

**Details:**

- **Material: Nylon**
- **Color: naturalny**
- Black Nylon, PE, black PE, PP, POM available on special order
- Other colours available on special order

Symbol	For thread	Int. diameter d	Ext. diameter D	h	Height H	Material	Color	Standard pack	Notes
		[mm]	[mm]	[mm]	[mm]			[szt./pcs]	
BL-PZPW-3-R1/4	-	13.2	18.9	2.6	4.5	PA	natural	500	R 1/4"