

BL-POK258 - Wing grips

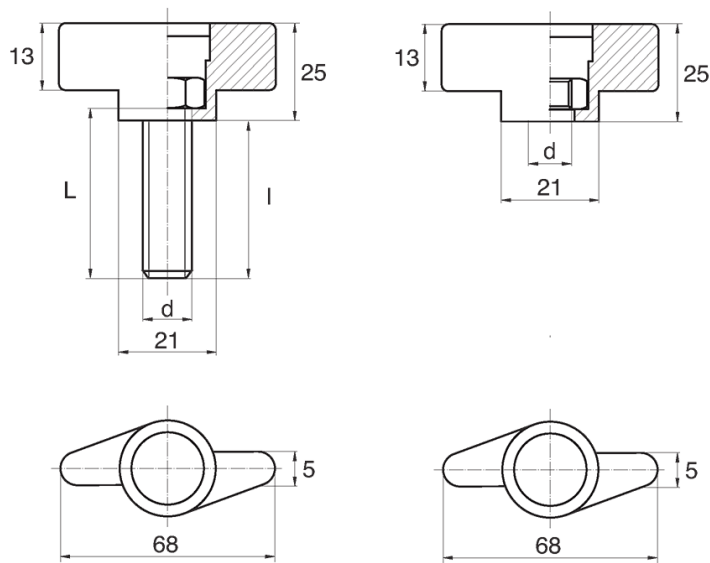

Details:

- **Handle material:** Nylon
- **Handle colour:** black; other colours available on special order
- Thread material: see table; For type M stainless steel, brass and aluminium available on special order
- Type:
 - F - female
 - M - male
- Standard pack: 100 pcs

Symbol	Type	Ext. thread d	Int. thread d	Thread material	L	l ±1mm	Material	Color
					[mm]	[mm]		
BL-POK258M-M8-25	M	-	M8	zinc-plated steel	25	20	PA	black