

**BL-POK258 - Wing grips**

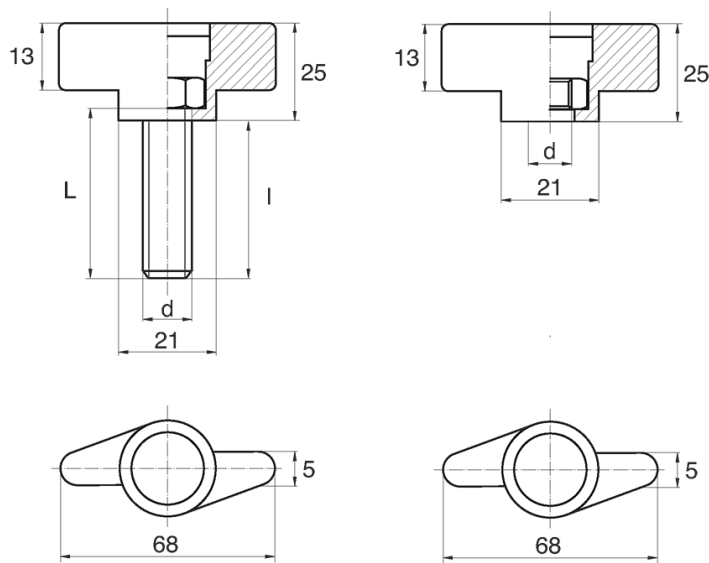

**Details:**

- **Handle material: Nylon**
- **Handle colour: black**; other colours available on special order
- Thread material: see table; For type M stainless steel, brass and aluminium available on special order
- Type:
  - F - female
  - M - male
- Standard pack: 100 pcs

Symbol	Type	Ext. thread d	Int. thread d	Thread material	L	l ±1mm	Material	Color
					[mm]	[mm]		
BL-POK258F-M8-2	F	M8	-	stainless steel	-	-	PA	black