

BL-POK195 - Triangular handwheels

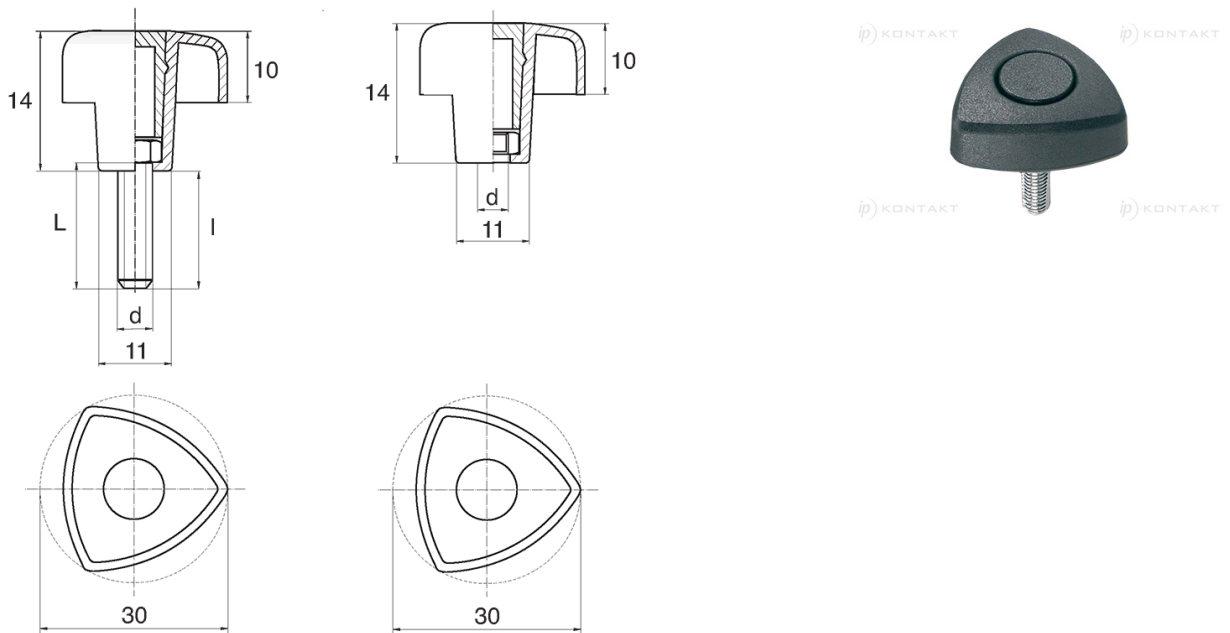

Details:

- **Handle material: Nylon**
- **Handle colour: black**; other colours available on special order
- Thread material: see table; For type M stainless steel and brass available on special order
- Type:
 - F - female
 - M - male
- Standard pack: 100 pcs

Symbol	Type	Ext. thread d	Int. thread d	Thread material	L	l ±1mm	Material	Color
					[mm]	[mm]		
BL-POK195M-M6-50	M	M6	-	zinc-plated steel	50	47	PA	black