

BL-POK195 - Triangular handwheels

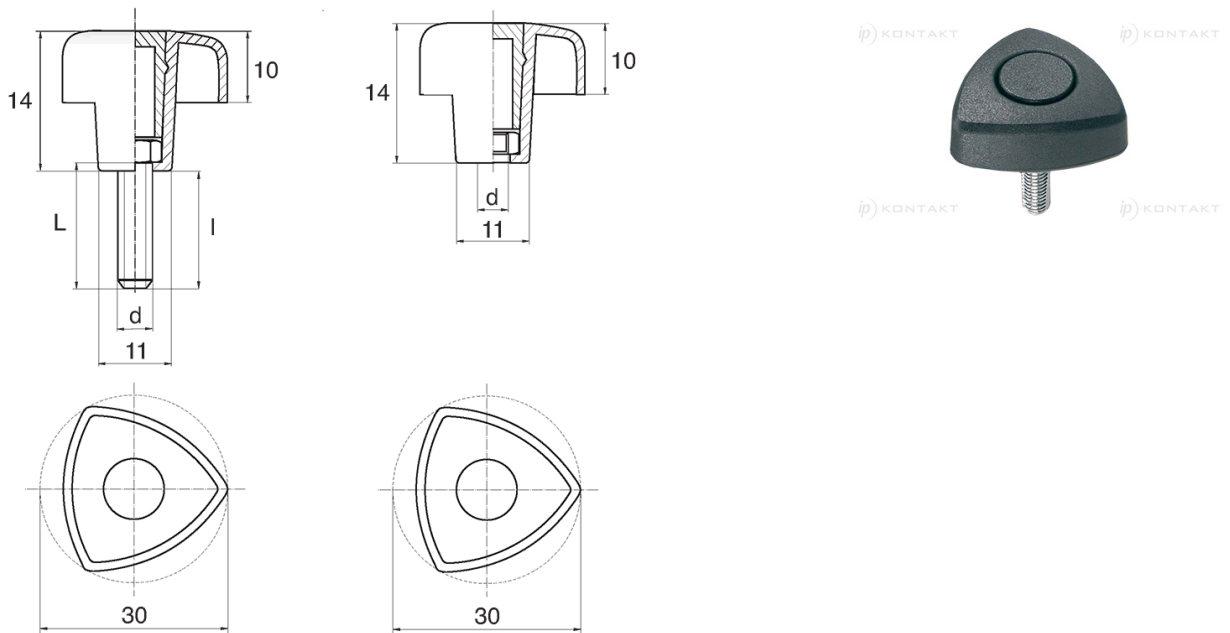

Details:

- **Handle material:** Nylon
- **Handle colour:** black; other colours available on special order
- **Thread material:** see table; For type M stainless steel and brass available on special order
- **Type:**
 - F - female
 - M - male
- **Standard pack:** 100 pcs

Symbol	Type	Ext. thread d	Int. thread d	Thread material	L	l ±1mm	Material	Color
					[mm]	[mm]		
BL-POK195M-M5-12	M	M5	-	zinc-plated steel	12	9.5	PA	black