

BL-POK185 - Four-point star grip

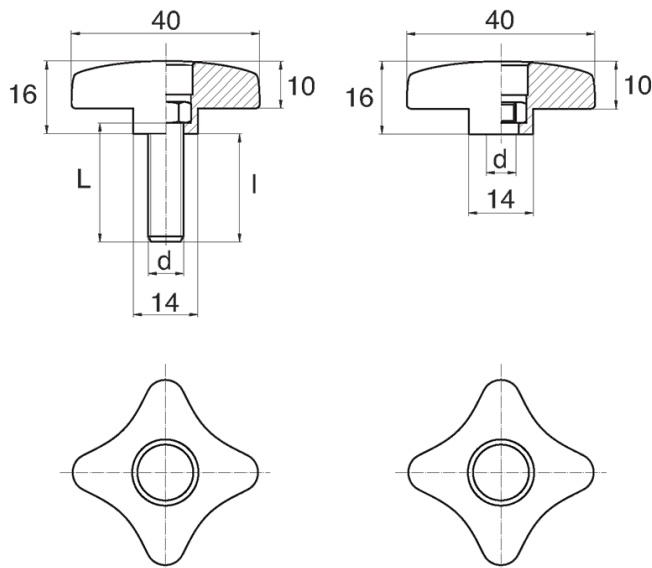

Details:

- **Handle material:** Nylon
- **Handle colour:** black; other colours available on special order
- Thread material: see table; For type M stainless steel and brass available on special order
- Type:
 - F - female
 - M - male
- Standard pack: 100 pcs

Symbol	Type	Ext. thread d	Int. thread d	Thread material	L	l ±1mm	Cap	Material	Color
					[mm]	[mm]			
BL-POK185M-M6-12	M	M6	-	zinc-plated steel	12	9	No	PA	black