

BL-OTG - Round spacers with metric thread

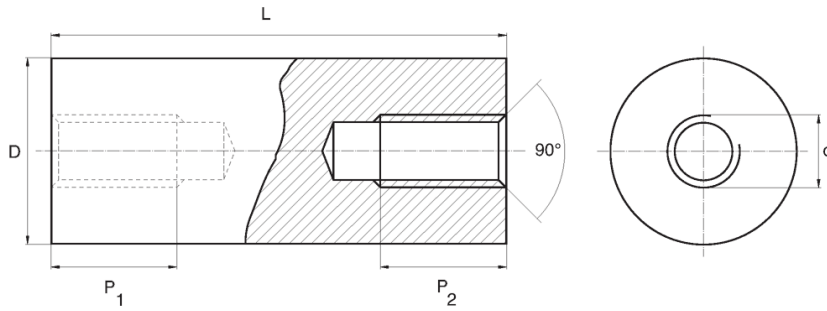

Details:

- **Material: POM**
- **Colour: natural**
- Materials available on special order: Nylon, white PTFE
- Working temperature: -30°C to +110°C

Symbol	Int. thread d	Ext. diameter D	Int. thread length P1 = P2	Height L	Material	Color
		[mm]	[mm]	[mm]		
BL-OTG-M4-50	M4	8	10	50	POM	natural